



Performance Evaluation of Modern Sophisticated Parking Management System with Space Modeling

Bandu Nandekar, Dr. Ranjana Raut, Dr. Pravin Dakhole

Research Scholar YCCE, Nagpur, India

Associate Professor, Dept. of Electronics, SGB, University, Amaravati, India

Professor, Dept. of Electronics, YCCE, Nagpur, India

ABSTRACT: This paper deals with the modern sophisticated parking system with space management based on IR and Ultrasonic sensor network. In this system shortest path of the slot can be monitored, system help us to prevent the vehicle from theft also used to model the space of the slot as per the width of the vehicle. This system is centrally controlled by WSN and Microcontroller and the display shows that availability of slot as per the width as well as the payment of the parked vehicle at the entry. This system is very effectively useful as compared to the existing parking system because it use to minimize the time consumed for finding the nearest available space

KEYWORDS: IR and Ultrasonic Sensor Network, Microcontroller unit and Space Modeling System.

I. INTRODUCTION

Today, the parking issue is becoming a serious for the vehicle owner in most of the cities. Aim of the work is to design automatic parking system which can help common people to park their vehicles in less space and secure environment. Due to dense population in modern era parking space has been one of the major issues whenever certain infrastructure is created. The limited availability of parking space result in traffic congestion, air pollution, fuel and time wastage as well as drivers frustration. The modern and sophisticated parking management system utilizes various technologies to efficiently manage and optimize the space are very useful to solve emerging parking problems. In this research work WSN technologies has attracted and increase attention of the user and are rapidly growing in various fields which expected to provide an efficient and cost effective solution for parking and space management system [3,5].

IR and Ultrasonic sensors N/W consists of large number of low cost sensor node which are deployed in the sensing area. They can sensor sample and process the information gathered from the sensing area, and transmit it to local controller to main controller through RF module [2,6].

The next part of this paper is to indicate the position of parked and vacant slot. For this purpose IR and Ultrasonic sensors are used. RFID is a very useful technology is used in locking and unlocking of car parking system. It will automatically deduct the amount and open the barricades for parking. The technology requires some extent of cooperation of an RFID reader and an RFID tag. RFID reader is connected to microcontroller in the control office. RFID reader automatically read the information from tag through built in antenna. The received information match with the data base, the control office will send a command to open the barrier [7,20].

The main part of this paper is to optimize the un utilize space between two slots.[4,5] The utilization of this work can be depend upon the width of the car, for this purpose installing modern and sophisticated parking management system which is being widely used to provide better parking facilities. This system is very helpful for preventing car thefts in the parking area and also for thorough detection of the vehicles before parked [6].



International Journal of Innovative Research in Computer and Communication Engineering

(An ISO 3297: 2007 Certified Organization)

Vol. 2, Issue 11, November 2014

II. RELATED WORK

1) Some of the initial studies focused on the applications of car parking system using sensor technologies adopted video sensors/cameras to collect the information in car parking field [1]. However the use of sensors has certain disadvantages, of which the two main disadvantages includes; a video sensor is energetically expensive, and a video sensor generate a very large amount of data which often poses difficulty in transmission in a wireless network.

2) Bi Yan-Zhong, Sun Li-Min, Zhu Hong-Song and Yan Ting-Xin [2], have designed a system which includes three kinds of nodes and a management station for central control. Each kind of nodes plays a different role in the system, and communicates directly or indirectly with other kinds of nodes. They collaborate with each other to accomplish topology formation, route establishing, parking space status sensing and reporting and command processing.

3) Wireless Sensor Networks (WSN) has attracted a great amount of attention in recent years [3]. A WSN consists of a large number of low-cost sensor nodes which can be self-organized to set up an ad hoc network via the wireless communication module equipped on the nodes. Taking the advantages of wireless communication and sensing, WSNs have already found many civil and military applications. With the imminent demand of the automobiles and the demand on intelligent parking systems, the use of WSN in these systems has caught the eye of the researchers more so in the last few decades. In this section some of the recent work in this area is presented.

4) Vanessa W.S. Tang, Yuan Zheng and Jiannong Cao, in their work [4] proposed a WSN-based intelligent car parking system which used wireless sensors deployed into a car park field, with each parking lot equipped with one sensor node, which detects and monitors the occupation of the parking lot. They have implemented a prototype of their system using crossbow nodes. The system demonstrated the effectiveness of our design and implementation of the parking system.

5) Xiaolong Li and Uma Kanth Ranga in their work "Design and Implementation of a Digital Parking Lot Management System" [5], designed a digital vehicle management system using radio frequency identification (RFID) technology. This digital vehicle management system will enhance the utilization of parking space and help user check the availability of the parking space remotely since the system is connected to the Internet.

6) Nayab Suhail Hamirani, Imdad Ali Ismaili, Asad Ali Shaikh, Faheem Ahmed and Azhar Ali Shah, in their work, have used ATMEL microcontroller as the main processor along with LCDs and motors as complimentary components for display and rotation [6]. Their model is based on circular mechanism giving low cost, less space and optimum performance. Password locking system is used to verify the object and detects number of free spaces available in the parking lot.

7) Mingkai Chen and Tianhai Chang, in their work [7] have designed an efficient parking systems using WSN concepts. They used three kinds of nodes namely monitoring nodes, routing nodes and sink node. The monitoring nodes would detect the status of every parking space, and transmit the information through routing nodes hop by hop to the sink node. The sink node connects to the information and management centre through RS-232 interface. After processing the data, the information and management centre will send the message to all the nodes and update the information in LED screen at the entrance of the parking lot.

8) Rakesh Kumar, Naveen K Chilamkurti and Ben Soh [8], presented a valuable comparison data for different sensors using different type of software functions and hardware components. The main goal of their work was to present a simple, automated analysis and comparison of power management, communication efficiency and threshold times using different sensors and a corresponding prediction of the above features. The results show a clear difference in various parameters by using different types of sensors for vehicle detection.

International Journal of Innovative Research in Computer and Communication Engineering

(An ISO 3297: 2007 Certified Organization)

Vol. 2, Issue 11, November 2014

III. SYSTEM ARCHITECTURE

A. Hardware Implementations:



Fig. 1. Lay out of Parking System

Now a days the parking systems are available to indicates the parking slots but are not model the space of the available slot and it does not indicate the shortest distance of empty parking slot. The main aim of Modern and Sophisticated Parking Management system is to find the nearest slot with the help of IR sensors. This system is required the following necessary hardware [9,10].

1] IR Sensors or Infrared TX / RX Module:

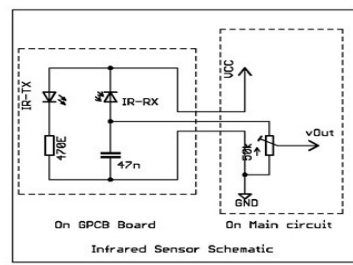

Fig. 2 The circuit diagram of IR Sensor

Infrared LED as a transmitter and Photo diode as a receiver both are arrange in a parallel manner. This module is used the detect reflecting cast iron surface and used for obstacle detection. IR LED emits infrared radiation continuously, when vehicle pass on it reflect the infrared light. This reflected light is made incident on reverse bias junction of this photodiode, the electron hole pair are generated, which result in reverse leakage currents. This reverse leakage current pass through resistor so as to get proportional voltage. This current varies accordingly intensity of incident rays. This voltage can be given to OP-AMP comparator compare this voltage with reference voltage and gives digital output in the form of zero and one or on chip ADC in AVR microcontroller to measure this voltage and used in software. The circuit depicts the schematics for an infrared sensor which allows to detect nearest an empty parking slot's from the Modern and Sophisticated parking management system. IR LED emits infrared radiation. These IR sensors which are made on the surface of the floor are used to decide the shortest path to find the empty slot.

2] Local MCU :

A group of such sensors units as described above is required to make a line follower vehicle detection system. We generally use 8-10 sensor unit to make line sensor array[19]. Every sensor individually wired with MCU. The output of IR sensors are connected or wired with ATmega324 microcontroller through port A, port B, and port C. The ATmega324 is a new and enhanced version of the ATmega32. In addition to the ATmega32 features, it contains dual USART, two more PWM channels and can run up to 20MHz with 32kB flash, 1024B EPROM, 2048 SRAM with a required power supply 2.7 to 5.5Volt. When the sensors output send request to Local MCU about the nearest path and

International Journal of Innovative Research in Computer and Communication Engineering

(An ISO 3297: 2007 Certified Organization)

Vol. 2, Issue 11, November 2014

empty parking slot it will make a proper frame format of the status of the sensors and send it to the main control node MCU. The output of the sensor will transmit wirelessly through RF module to MCUAtmega324.

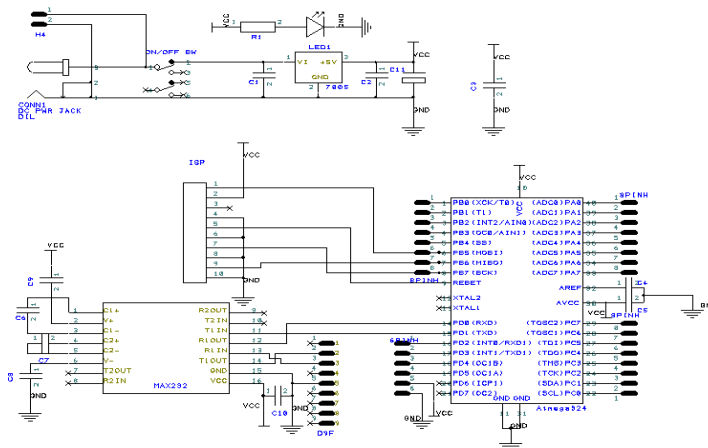

Fig. 3. Interfacing of IR Sensors with MCU.

3] RF Module:

There are three types Wireless RF Modules, Transmitter, Receiver and a Transceiver. These RF Modules are designed to serve as a tool for electronic design to perform wireless experiments. The Transmitter, Receiver and Transceiver all have 9600 baud serial interfaces and stand-alone, 3 function switch inputs and outputs. The modules can communicate over distances up to 250 feet. The boards operate on +5V and easily interface to your Basic Stamp 2 or Basic Stamp 2sx, apply +5VDC, ground, and the communication pins you require and enjoy hassle free wireless communications.

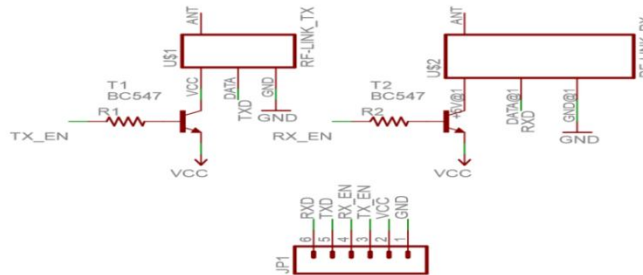

Fig. 4. RF Transmitter & Receiver.

4] Main MCU:

MCUAtmega324 read each Path sensor one by one and will make a proper frame format **\$\$\$-----status--of--all--sensors-----#**. Status of 24 sensors in the form of 1 and 0. Digit 1 means that there is empty parking slot and 0 means the vehicle is parked. USART 0 and 1 the comparative output signals sends to PC via RS232 protocol. To interface RS232 level signals to MCU we need a "Level converter". What a level converter will do is to convert RS232 level signals (HIGH= -12V LOW= +12V) from PC to TTL level signal (HIGH= +5V, LOW= 0V) to be fed to MCU and **also the opposite**. As RS232 protocol is such a common protocol there is a dedicated IC designed for this purpose of "Level Conversion".

International Journal of Innovative Research in Computer and Communication Engineering

(An ISO 3297: 2007 Certified Organization)

Vol. 2, Issue 11, November 2014

5] RFID Module:

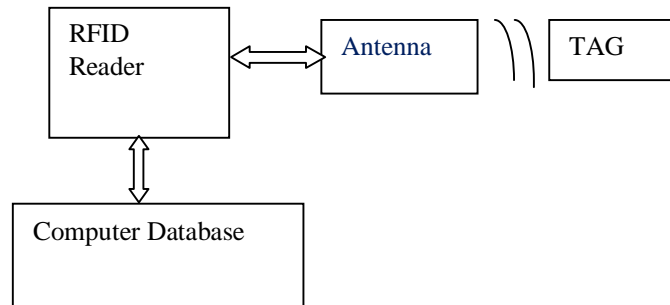

Fig. 5. Standard RFID System

RFID systems comprise three basic elements: a tag, a reader and software. Typically, a reader transmits radio signals that are received by an antenna attached to the tag. The tag sends a unique reply signal back to the reader. Which is then decoded into an identification number. This ID number is unique to the tag. Ideally, a global set of standards will dictate how these ID numbers are assigned and insure that there are no repetitions or duplications. Readers are linked to computers, where identification numbers are matched with specific relevant information. There are also more sophisticated and expensive tags that can stored information in addition to ID numbers directly in the tag. Battery powered tags are called “active tags” [22]. The transponders in automobiles or in parking system used to pay parking charges and operate the locking system when they pass near readers are active RFID tags. Passive tags on other hand, are powered by the signal from the readers. Active tags can be read greater distance than passive tags.

6] IR Sensors and Motor:

Each slot is designed for a medium sized vehicle. If a small vehicle enters the slot, then the slot size is reduced by some amount with the help of motor and send request to local controller, for a large vehicle vice versa. This process is repeated for each of the slots[18]. The size of the vehicle is identified by a ultrasonic sensors, with motor arrangement. IC 1392d works on the concept of H-bridge. H-bridge is a circuit which allows the voltage to be flown in either direction. As you know voltage need to change its direction for being able to rotate the motor in clockwise or anticlockwise direction, Hence H-bridge IC are ideal for driving a DC motor. In a single l293d chip there two h-Bridge circuit inside the IC which can rotate two dc motor independently.

7] Barricades:

This arrangement used at the entry of the vehicle and at each of the slot. Barricades at the entrance indicate the availability of the slots either small, medium or large. If space is available but not for large vehicle, at that time that hold the vehicle up to the space made available or suggest the driver to use another parking field. Another use of Barricades with RFID module is to pay parking charges and operate the locking and unlocking system. This used to prevent the vehicle from theft.

8] Display:

This unit consists of LCD display and arrow like LED array display unit to show the shortest path of the slot. The parking slot availability is display by red and green LED [14].

B. Software Implementations:

1] Architecture of Slots:

Architecture shows that the arrangement of empty slots and the position of sensors. There are twenty empty slots and thirty six IR sensors that shown in figure [3].

International Journal of Innovative Research in Computer and Communication Engineering

(An ISO 3297: 2007 Certified Organization)

Vol. 2, Issue 11, November 2014

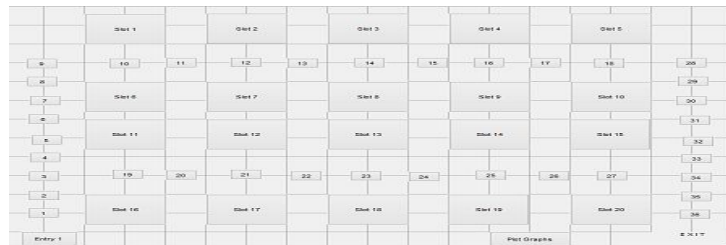

Fig. 6. Architecture of Slot in Parking System.

2] Space Modelling:

Each slot is designed for a medium sized vehicle. If a small vehicle enters in the modern sophisticated parking management system then the slot size is reduced by some amount, similarly if a large vehicle enters the slot, the slot size is increased by some amount. This process is repeated for each of the slots [15,16]. The size of the vehicle is identified by a simple IR sensor, with motor arrangement. When slots are empty there is no signal from local controller to main controller. As soon as vehicle enters in each slot, sensors are activated and send signal to local controller and local controller to main controller at the same time sensors at the side barricades get on and start working, the horizontal movement of the sensor given to the local controller where the motor drivers are connected that decides the movement of motor clockwise or anti- clockwise.

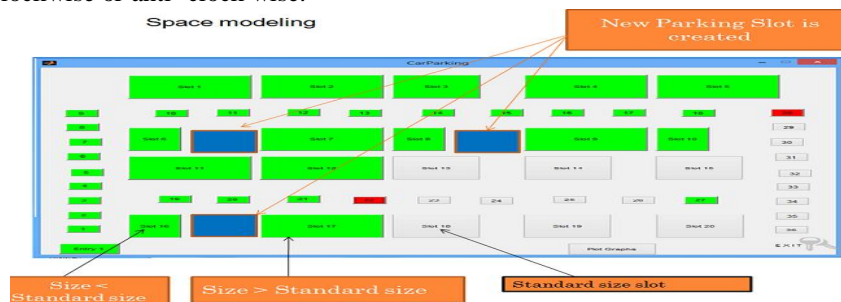

Fig. 7. Sensor Motor arrangement for Space Modeling..

3] Algorithm of space Modelling

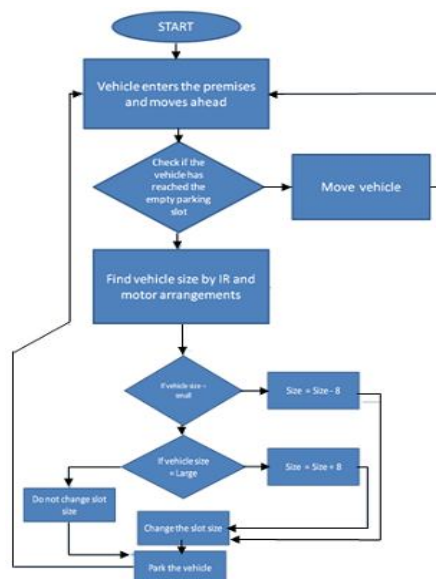

Fig.7. Algorithm for Parking System with Space Modelling.

International Journal of Innovative Research in Computer and Communication Engineering

(An ISO 3297: 2007 Certified Organization)

Vol. 2, Issue 11, November 2014

IV. SIMULATION RESULTS

Figure 8. shows that shows the occupancy of sensors in the system. Which indicates the number of sensors occupied in the system with respect time.

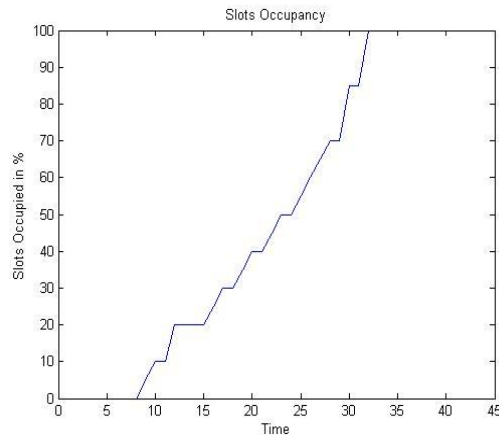

Fig.8. Occupancy of Sensors wrt time.

Fig. no. 2. This graph shows the percentage of total slots occupied in the system with respect time. In this graph we can see that as the time advances the number of occupied slots increase too, but this would not be true always, as when cars would leave the system the graph would indicate a reduction in value thereby showing that the slots are empty in the system.

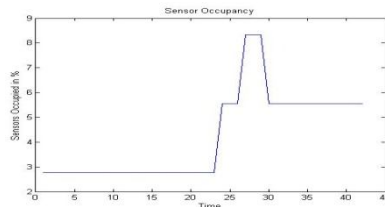

Fig. 9. Percentage of Occupied slot in the System.

This is the most important parameter and is found out after space modelling. In this case we can see that how efficiently the space has been modelled in our system, the higher this index is, the more efficiently space modelling is working in our system.

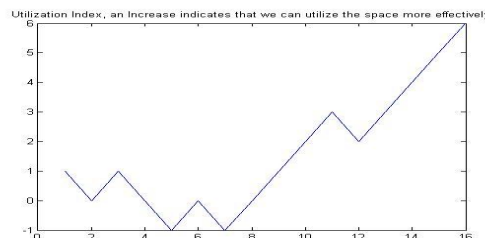

Fig. 10. Index of Space Modeling System.

V. CONCLUSION

This paper introduces modern sophisticated parking management system (MSPMS) based on wireless sensor network, RFID module and MCU. We developed (MSPMS) hardware design with sensor nodes for vehicle parking and



International Journal of Innovative Research in Computer and Communication Engineering

(An ISO 3297: 2007 Certified Organization)

Vol. 2, Issue 11, November 2014

to find the nearest slot. MCU with RF module is used to guide the management of parking area and space optimization. MSPMS system is employ advanced technologies to permit efficient use of parking space with optimization. Smart parking ranges from simple systems shows the way of available slots as well as the nearest slots but it is very complex that can model the space. The central coordinator can easily operate the payment token, with the help of this we can prevent vehicle from theft. The management system can monitors the step by step approach of parking scenario. This system will enhance the utilization of parking space and find the shortest distance to park the vehicle and help the user to find the availability of parking space within short period of time. Therefore this system achieves significant role in latest parking and management system.

REFERENCES

1. Bi Yan-Zhong, Sun Li-Min, Zhu Hong-Song and Yan Ting-Xin, "A Parking Management System Based on Wireless Sensor Network" Vol. 32, No. 6 ACTA AUTOMATICA SINICA November, 2006. Vanessa W.S. Tang, Yuan Zheng and Jiannong Cao, "An Intelligent Car Park Management System based on Wireless Sensor Networks", 1st International Symposium on Pervasive Computing and Applications.
2. Rakesh Kumar, Naveen K Chilamkurti and Ben Soh, "A Comparative Study of Different Sensors for Smart car park Management", International Conference on Intelligent Pervasive Computing, 2007.
3. C. Shen, C. Srisathapornphat and C. Jaikaeo, "Sensor Information Networking Architecture and Application", IEEE Pers, Communication, Aug2001, pp52-59. <http://www.intel.com/technologyserearch/rs11031>.
4. Xiaolong Li and Uma Kanth Ranga, "Design and Implementation of a Digital Parking Lot Management System" Technology Interface Journal 2009.
5. Mingka i Chen and Tianhai Chang, "A Parking Guidance and Information System based on Wireless Sensor Network", IEEE Inter a. tional Conference on Information and Automation Shenzhen China 11.
6. Mingkai Chen, Chao Hu and Tianhai Chang, "The Research on Optimal Parking Space Choice Model in Parking Lots", The Chinese University of Hong Kong , 978-1-61284-840-2/11 , 2011 IEEE.
7. S.-Y. Cheung, S. Coleri Ergen and P. Varaiya, "Traffic surveillance with wireless magnetic sensors" 12th ITS World Congress, Nov. 2005.
8. Nayab Suhail Hamirani, Imdad Ali Ismaili, Asad Ali Shaikh, Faheem Ahmed and Azhar AliShah, "Password Based Rotational Multistory Car Parking System", Journal of Emerging Trends in Computing and Information Sciences, December 2011.
9. Vanessa W.S. Tang, Yuan Zheng and Jiannong Cao "An Intelligent Car Park Management System based on Wireless Sensor Networks" 1st International Symposium on Pervasive Computing and Applications.
10. M.Y.I. Idris, E. M. Tamil, Z. Razak, and L.W. Kin, "Smart parking system using image processing techniques in wireless sensor network environment", Information Technology Journal 8(2): 114-127, 2009 ISSN 1812-5638 © 2009 Asian Network for Scientific Information.
11. Ms.SAYANTI BANERJEE, Ms.PALLAVI CHOUDKAR and Prof.M.K.MUJU "IMPLEMENTATION OF IMAGE PROCESSING IN REAL TIME CAR PARKING SYSTEM", Indian Journal of Computer Science and Engineering (IJCSE), ISSN : 0976-5166 Vol. 2 No. 1.
12. Seong-eun Yoo, Poh Kit Chong, Taisoo Park, Youngsoo Kim, Daeyoung Kim Changsub Shin, Kyungbok Sung and Hyunhak Kim "DGS: Driving Guidance System based on Wireless Sensor Network", 22nd International Conference on Advanced Information Networking and Applications - Workshops, 978-0-7695-3096-3/08 \$25.00 © 2008 IEEE DOI 10.1109/WAINA.2008.184.
13. Todd Litman Victoria Transport Policy Institute " Parking Management Strategies, Evaluation and Planning", An shorter version of this paper was presented at the Transportation Research Board 2007 Annual Meeting, Paper 07-1581.
14. M.Y.I. Idris, E. M. Tamil, Z. Razak, and L.W. Kin, "Parking guidance system utilizing wireless sensor network and ultrasonic sensors", Information Technology Journal 8(2): 138-146, 2009 ISSN 1812-5638 © 2009 Asian Network for Scientific Information.
15. Thomas B. Hodel / Suo Cong "Parking Space Optimization Services, a uniformed Web Application Architecture", University of Zurich, Department of Information Technology, Database Technology Research Group Winterthurerstr. 190, Bau 27 - J26, CH-8057 Zürich, Switzerland.
16. Thomas B. Hodel-Widmer, University of Zurich Suo Cong, University of Zurich "PSOS, Parking Space Optimization Service", 4th Swiss Transport Research Conference Monte Verità / Ascona, March 25-26, 2004.
17. Dusan Teodorovic Panta Lucie "PARKING SPACE INVENTORY CONTROL: AN ARTIFICIAL INTELLIGENCE APPROACH", Dept. of Civil Engineering - Virginia Tech.
18. Hitendra.G.Wasnik, Dr. R.D.Askhedkar and Dr. S.K. Choudhary "Optimal Automatic Car Parking System for Indian Environment", Indian Streams Reserach Journal, Vol.1, Issue X/Nov; 11pp.1-4, ISSN:-2230-7850.
19. Vivekanand P. Thakare and N. A. Chavan, "Performance Evaluation of Parking Guidance and Management System using Wireless Sensor Network" IJRTE ISSN: 2277-3878, Volume-1, Issue-2, June 2012.
20. HBeon Labs "RFID Based Automatic Car Parking System", Off. No. 46, 1st Floor, Kadamba Complex Gamma-I, Greater Noida (India) - 201308 , Project Report.
21. Rakesh Kumar, Naveen K Chilamkurti and Ben Soh, "A Comparative Study of Different Sensors for Smart car park Management", International Conference on Intelligent Pervasive Computing, 2007.
22. Dara J. Glasser, Kenneth W. Goodman and Norman G. Einspruch, "Chips, tags and scanner: Ethical challenges for radio frequency identifications", Ethics and Information Technology (2007) 9:101-109, DOI 10.1007/s10676-006-9124-0.

BIOGRAPHY

Bandu Y. Nandekar is a Research Scholar in the Electronics Department, Yashwantrao Chavan College of Engineering, Nagpur. He received Master of Technology (M. Tech) degree in 2011 from RTMNU, Nagpur, MS, India. His research interests are Wireless Sensor Network in ITS etc.

Dr. Ranjana D. Raut is a Associate Professor in the Applied Electronics Department, SGM Amaravati University, Amaravati, MS, India.

Dr. Pravin Dakhole is a Professor in the Electronics Department, Yashwantrao Chavan College of Engineering, Nagpur, MS, India.