



International Journal of Innovative Research in Computer and Communication Engineering

(An ISO 3297: 2007 Certified Organization)

Vol. 2, Issue 1, January 2014

Scalable Management Strategies using Mobile Agents in Optical Transport Network

Anish Saini¹ & Dr. Atul Mishra²

Assistant Professor, Department of Computer Science & Engineering, Echelon Institute of Technology, Faridabad, India¹

Associate Professor, Department of Computer Engineering, YMCA University of Science & Technology Faridabad, India²

ABSTRACT: Network Management is a critical issue in today's rapidly changing network environment. Centralized client server networks are having problems such as scalability, reliability, interoperability and flexibility. Mobile agents decentralize the processing and control, thereby reducing the management traffic around the management station and distribute processing load. Network management based-on Mobile Agent refers to equipping agents with network management intelligence and allowing them to issue requests to managed devices/objects after migrating close to them. Client server based model is better for smaller network whereas mobile agents are better for large network. Cost comparison of MA v/s client server with a view to study their comparative performance is shown in this paper.

An Application of mobile agent in setting up λ - connections through an optical transport network (OTN) is also shown, which includes brief introduction to optical network, OTN layer architecture (a type of optical network), a ROADM switch (which is used for ADD/DROP of optical channels in optical network) and proposed an algorithm to create a logical connection in a node consisting of optical channels. Experimental results for cost comparison show the comparative performance of MA v/s client server.

Keywords: Client/Server NMS, Mobile agent based NMS, SNMP request, SNMP response, WDM.

I. INTRODUCTION

Network Management is performed on the basis of basic client server model. In these models Network manager acts as client, it send request to managed devices to get information about their current status and managed devices acts as server which send response to manger according to their request. These client server models having their prone and cons. The client server models inherent some issues which have a major effect on network resource are Centralized Management, Scalability, Bandwidth wastage, Response time, Fault Tolerance. Mobile Agent models handle these challenges of client server based network management model. Mobile agent is an autonomous entity that visits to remote node to perform some operation locally according to status of remote node.

In mobile agent based approaches the management activities are not performed at centralized node but distributed to different mobile agent.

These mobile agents visit managed node and perform manage operation on remote node. MA resolves C/S issues of Network Management Models as Distributed Management, Scalability, Efficient Bandwidth Utilization, Reduce Response time, Fault Tolerance.

Mobile Agent models handle these challenges of client server based network management model. Mobile agent is an autonomous entity that visits to remote node to perform some operation locally according to status of remote node.

In mobile agent based approaches the management activities are not performed at centralized node but distributed to different mobile agent.

These mobile agents visit managed node and perform manage operation on remote node. MA resolves C/S issues of Network Management Models as *Distributed Management, Scalability, Efficient Bandwidth Utilization, Reduce Response time, Fault Tolerance.*

II. RELATED WORK

Modern days, client server based network management models suffer from the well-known problems of centralized system i.e. lack of distribution. The client/server based Network management system leads to centralized system, based on SNMP or CMIP management protocol, which does not solve the problem of scalability and flexibility. SNMP V2 also adds improvements in the area of manager to manager communication. GetBulkRequest has been added to retrieve

International Journal of Innovative Research in Computer and Communication Engineering

(An ISO 3297: 2007 Certified Organization)

Vol. 2, Issue 1, January 2014

large data amounts by a single request. Earlier getNextRequest is used iteratively in order to get a bulk of data. SNMP v2 security system is too complex. [1] SNMP V3 provides better security in the form of authentication via hashing, timestamps, and message confidentiality due to the use of encryption. SNMP & CMIP both address the problem of interoperability in heterogeneous environments [2]. SNMP manages and monitors only network elements and agents provide a limited and fixed set of functions [3].

The network management activities, dealing with data gathering and reporting methods, involve substantial transmission of management data thereby consuming a lot of bandwidth and computational overhead. This leads to a considerable strain on the network and significant traffic jam at the manager host. Besides this centralized management activities are limited in their capability as they cannot do intelligent processing like upfront judgment, forecasting, analyzing data and make positive efforts to maintain quality of service.

These problems introduce, moving toward distributed or decentralization of network system [4]. Several distributed management architectures like CORBA, JAVA, including mobile agent technology, have been recently proposed to answer the scalability limitations of centralized models and the flexibility problems of different network models. In this kind of communicating applications with approaches like Management by delegation, Common Object Request Broker Architecture (CORBA) [5], implement real-life heterogeneous distributed applications. Web-based management integrates all types of information systems into the internet or intranet environment [6]. Intelligent agents are introduced to communities of intelligent process to communicate for common task [7]. Active networks are framework which is used for transporting components to program and make them to execute code in order to achieve higher flexibility [8].

Code mobility is widely used by a new family of programming languages, generally called mobile code languages [9, 10]. Mobile codes are recognized as software that move to a heterogeneous networks environment, crosses different administration domains, and are automatically executed upon arrival at their destinations [11].

III. COST ANALYSIS OF CLIENT/SERVER V/S MA BASED MODEL

Two model work in a real environment and what is there impact on response time and network bandwidth utilization.

In client server approach, a manager at node0 send SNMP request to all nodes i.e. (node1, node2 and node3) and get SNMP response from them as shown in fig 1. Each manager node have to sent SNMP request to each node and corresponding to this request managed node send SNMP response which leads to the inefficient utilization of bandwidth and jamming in network traffic

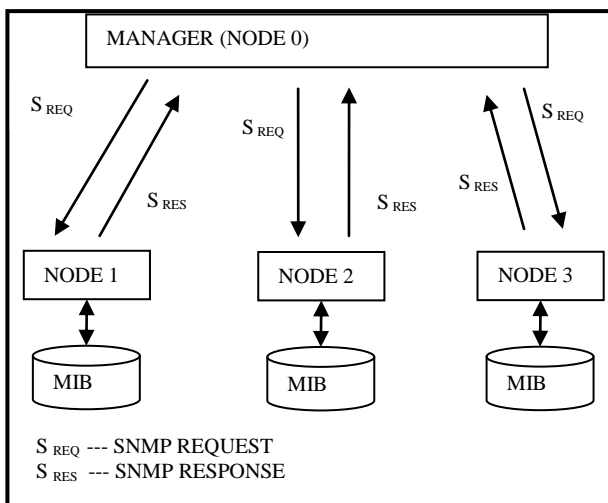

Fig.1 Static Agent based network management

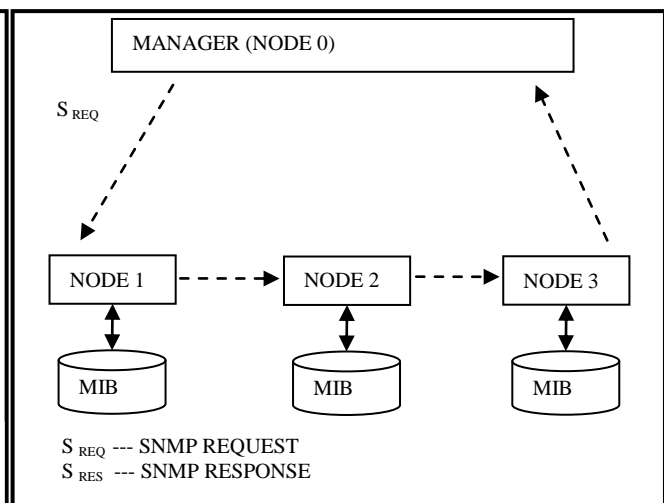

Fig.2 Mobile Agent Based Network management

International Journal of Innovative Research in Computer and Communication Engineering

(An ISO 3297: 2007 Certified Organization)

Vol. 2, Issue 1, January 2014

In case of mobile agent based network request-response does not passes through network links, mobile agent do these all request-response operation locally at each node as shown in fig 2. In this network only Mobile agent with collected information is passes trough network links.

IV. MATHEMATICAL FORMULAS FOR NM COST

Network management traffic i.e. (get_request & set_request) passes through system network have some cost associated with it. This cost can be in term of bandwidth acquired for management data transfer or in term of time for which network is not free size private use. Each model has different cost for network management traffic. It is one of research topic that how to minimize the network management cost. The cost for network management does not only depends on management data size but also depends on cost coefficient of network link through which management data pass. To compare this cost there are some formulas here.

For C/S or Static Agent based network management model as shown in fig 1, cost of only one time polling all network devices is would be computed as

$$C_{C/S} = K_{0,1} * (Sreq + Sres) + K_{0,2} * (Sreq + Sres) + K_{0,3} * (Sreq + Sres) \quad (1)$$

Equation 1 can be generalized for N number of nodes as shown in equation 4.2

$$C_{C/S} = \sum_{i=1}^n K_{0,i} * (\text{data through this link})$$

$$C_{C/S} = \sum_{i=1}^N K_{0,i} * (Sreq + Sres) \quad (2)$$

Where $K_{0,i}$: is cost coefficient of manager to managed node link,
Sreq : Size of SNMP request packet,
Sres : Size of SNMP response packet

If P is number of polling done for a time interval then cost for network management for that time interval would b calculated as shown in equation 3

$$C_{C/S} = (\sum_{i=1}^N K_{0,i} * (Sreq + Sres)) * P \quad (3)$$

For Mobile Agent based Network management model cost of only one round trip is shown in equation 4.4, as the request is not going from manager node to individual managed node every time & vice versa for response, MA traverse the whole path and then send the response to manager node .

$$C_{MA} = K_{0,1} * SMA + K_{1,2} * SMA + K_{2,3} * SMA + K_{3,0} * SMA \quad (4)$$

But as MA do operation locally at managed node, so it may require carrying some partial results (δpr) to the next node. In case of partial results the cost for mobile agent would be computed as shown in equation 5.

$$C_{MA} = K_{0,1} * SMA + K_{1,2} * (SMA + \delta pr) + K_{2,3} * (SMA + 2 * \delta pr) + K_{3,0} * (SMA + 3 * \delta pr) \quad (5)$$

In generalized form for N number of nodes the cost is computed for mobile agent is shown in equation 6.

$$C_{MA} = \sum_{i=0}^N K_{i,i+1} * (SMA + i * \delta pr) + K_{N,0} * (SMA + N * \delta pr) \quad (6)$$

Where $K_{i,j}$: is cost coefficient of link between ith and jth,
SMA : Size of mobile agent ,
 δpr : Size of partial results information collected by MA from each node.

δpr is zero if MA agent performs like as a manager and does not carries any information from managed device for further use. There is N+1 is number of network nodes and their index is starting from 0-N. If polling is done for a time interval for network management then management cost for that interval would be computed as shown in equation 7

International Journal of Innovative Research in Computer and Communication Engineering

(An ISO 3297: 2007 Certified Organization)

Vol. 2, Issue 1, January 2014

$$C_{MA} = (\sum_{i=0}^N K_{i,i+1} * (SMA + (i * \delta pr) + \delta d) + K_{N,0} * (SMA + (N * \delta pr) + \delta d)) \quad (7)$$

Where δd is some change in partial result as the number of times polling increases.

Thus from equation 3 and 7, we can observed that management cost in C/S Network management model is *directly proportional to number of request & response used to managed a device*. But in MA based model it is *directional proportional to MA agent size as well as amount of partial result information collected from mobile agent*.

V. THEORETICAL CALCULATIONS FOR NM COST

For theoretical calculation of management cost for above two networks management models as shown in figs 1 & 2 and consider following parameters

SNMP request packet size = 50 byte, SNMP response packet size = 75 byte where is 50 byte is data information in response packet, consider cost coefficient of all links between nodes i.e. (0-1,0-2,0-3 in fig 3 and 0-1, 1-2, 2-3, 3-0 in fig 4) is 10, MA size is 1 KB.

$$\begin{aligned} C_{c/s} &= K_{0,1} * (Sreq + Sres) + K_{0,2} * (Sreq + Sres) + K_{0,3} * (Sreq + Sres) \\ &= 10 * (50 + 75) + 10 * (50 + 75) + 10 * (50 + 75) \\ &= 3 * 10 * 125 \\ &= 3750 \text{ Bytes} \end{aligned}$$

For MA which collect information

$$\begin{aligned} C_{MA} &= K_{0,1} * SMA + K_{1,2} * (SMA + \delta pr) + K_{2,3} * SMA + 2 * \delta pr + K_{3,0} * (SMA + 3 * \delta pr) \\ &= 10 * 1024 + 10 * (1024 + 50) + 10 * (1024 + 100) + 10 * (1024 + 150) \\ &= 10 * (1024 + 1074 + 1124 + 1174) \\ &= 43960 \text{ Byte} \end{aligned}$$

When the node is accessing the MIB data, p times there may be some small change in data i.e partial results data information, so for multiple polling, cost of mobile agent is as:

For polling 5 times, we assume that only no change in the data.

$$\begin{aligned} C_{MA} &= K_{0,1} * SMA + K_{1,2} * (SMA + \delta pr + \delta d) + K_{2,3} * (SMA + (2 * \delta pr) + \delta d) + K_{3,0} * (SMA + (3 * \delta pr) + \delta d) \\ C_{MA} &= 10 * 1024 + 10 * (1024 + 50 + 0) + 10 * (1024 + 100 + 0) + 10 * (1024 + 150 + 0) \\ &= 10 * (1024 + 1074 + 1124 + 1174) \\ &= 43960 \text{ Byte} \end{aligned}$$

For polling 10 times, we assume that only 5 byte of data will be added at each node

$$\begin{aligned} C_{MA} &= K_{0,1} * SMA + K_{1,2} * (SMA + pr + \delta pr) + K_{2,3} * (SMA + (2 * pr) + \delta pr) + K_{3,0} * (SMA + (3 * pr) + \delta pr) \\ C_{MA} &= 10 * 1024 + 10 * (1024 + 50 + 5) + 10 * (1024 + 100 + 5) + 10 * (1024 + 150 + 5) \\ &= 10 * (1024 + 1079 + 1129 + 1179) \\ &= 44110 \text{ Byte} \end{aligned}$$

For polling 50 times, we assume that only 15 byte of data will be added at each node

$$\begin{aligned} C_{MA} &= K_{0,1} * SMA + K_{1,2} * (SMA + \delta pr + \delta d) + K_{2,3} * (SMA + (2 * \delta pr) + \delta d) + K_{3,0} * (SMA + (3 * \delta pr) + \delta d) \\ C_{MA} &= 10 * 1024 + 10 * (1024 + 50 + 15) + 10 * (1024 + 100 + 15) + 10 * (1024 + 150 + 15) \\ &= 10 * (1024 + 1089 + 1139 + 1189) \\ &= 44410 \text{ Byte} \end{aligned}$$

For polling 75 times, we assume that only 15 byte of data will be added at each node

International Journal of Innovative Research in Computer and Communication Engineering

(An ISO 3297: 2007 Certified Organization)

Vol. 2, Issue 1, January 2014

$$C_{MA} = K_{0,1} * SMA + K_{1,2} * (SMA + \delta pr + \delta d) + K_{2,3} * (SMA + (2 * \delta pr) + \delta d) + K_{3,0} * (SMA + (3 * \delta pr) + \delta d)$$

$$\begin{aligned} C_{MA} &= 10 * 1024 + 10 * (1024 + 50 + 15) + 10 * (1024 + 100 + 15) + 10 * (1024 + 150 + 15) \\ &= 10 * (1024 + 1089 + 1139 + 1189) \\ &= 44410 \text{ Byte} \end{aligned}$$

For polling 100 times, we assume that only 20 byte of data will be added at each node

$$C_{MA} = K_{0,1} * SMA + K_{1,2} * (S_{MA} + \delta pr + \delta d) + K_{2,3} * (SMA + (2 * \delta pr) + \delta d) + K_{3,0} * (SMA + (3 * \delta pr) + \delta d)$$

$$\begin{aligned} C_{MA} &= 10 * 1024 + 10 * (1024 + 50 + 20) + 10 * (1024 + 100 + 20) + 10 * (1024 + 150 + 20) \\ &= 10 * (1024 + 1094 + 1144 + 1194) \\ &= 44560 \text{ Byte} \end{aligned}$$

For polling 200 times, we assume that only 25 byte of data will be added at each node

$$C_{MA} = K_{0,1} * SMA + K_{1,2} * (SMA + \delta pr + \delta d) + K_{2,3} * (SMA + (2 * \delta pr) + \delta d) + K_{3,0} * (SMA + (3 * \delta pr) + \delta d)$$

$$\begin{aligned} C_{MA} &= 10 * 1024 + 10 * (1024 + 50 + 25) + 10 * (1024 + 100 + 25) + 10 * (1024 + 150 + 25) \\ &= 10 * (1024 + 1099 + 1149 + 1199) \\ &= 44710 \text{ Byte} \end{aligned}$$

Table 1 Theoretical Management cost $C_{C/S}$ Vs C_{MA}

| Number Of Times Polling Done | Cost for $C_{C/S}$ | Cost for C_{MA} |
|------------------------------|--------------------|-------------------|
| 1 | 3750 | 43960 |
| 5 | 18750 | 43960 |
| 10 | 37500 | 44110 |
| 50 | 187500 | 44410 |
| 75 | 281250 | 44410 |
| 100 | 375000 | 44560 |
| 200 | 750000 | 44710 |

Table 1 shows cost comparison between $C_{C/S}$ and C_{MA} to access multiple rows of MIB table of managed device by polling multiple times.

Fig 3 shows the graph of table 1 data values, which very clear represents that client server based model are good for small network but as a network grows, there is rapid increase in the demand of bandwidth, whereas in mobile agent based models they require high bandwidth for smaller network but shows better utilisation of bandwidth when the network becomes large.

The table 1 shows cost only access for devices parameters by manager, if manager check these all parameters and then again set their nominal value then it again required to sent set_request and get set_response for managed devices.

For managing each parameter in this way required to pass two pair of request and response through link between manager and managed device in static manager as in fig 1 and if MA in fig 2 acts as a mobile manager then there is no need to collect values of device parameters and they can be locally checked and set. In that case cost for management activity of for single table row is

$$\begin{aligned} C_{C/S} &= K_{0,1} * (S_{req} + S_{res}) * 2 + K_{0,2} * (S_{req} + S_{res}) * 2 + K_{0,3} * (S_{req} + S_{res}) * 2 \\ &= 3 * 10 * 125 * 2 \\ &= 7500 \text{ Bytes} \end{aligned}$$

For mobile manager value δpr is zero if managing activity is at managed node

International Journal of Innovative Research in Computer and Communication Engineering

(An ISO 3297: 2007 Certified Organization)

Vol. 2, Issue 1, January 2014

$$\begin{aligned}
 C_{MA} &= K_{0,1} * SMA + K_{1,2} * (SMA + \delta pr) + K_{2,3} * (SMA + 2 * \delta pr) + K_{3,0} * (SMA + 3 * \delta pr) \\
 &= 10 * 1024 + 10 * (1024 + 0) + 10 * (1024 + 0) + 10 * (1024 + 0) \\
 &= 10 * (1024) * 4 \\
 &= 40960 \text{ Byte}
 \end{aligned}$$

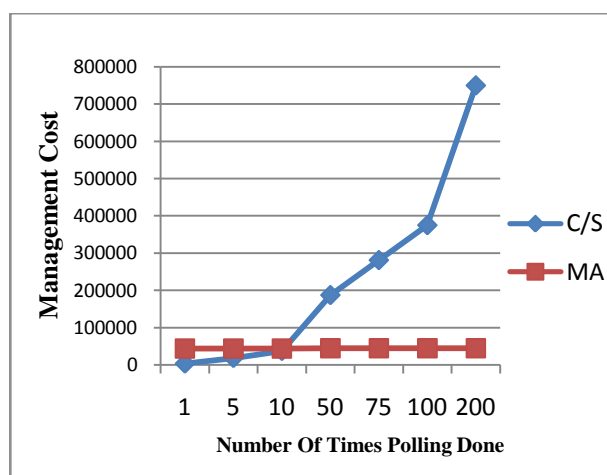

Fig 3 Graph of Table I Data Values

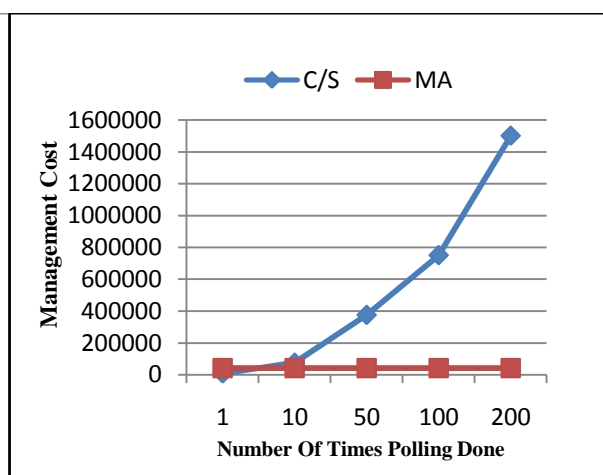

Fig 4 Graph of Table II Data Values

The table 2 shows, cost comparison between $C_{C/S}$ and C_{MA} to access managing multiple rows of MIB table of managed device and fig 4 shows the corresponding graph.

Table 2 Theoretical Management cost $C_{C/S}$ Vs C_{MA} when MA is a manager

| Number Of Times Polling Done | Cost for $C_{C/S}$ | Cost for C_{MA} |
|------------------------------|--------------------|-------------------|
| 1 | 7500 | 40960 |
| 10 | 75000 | 40960 |
| 50 | 375000 | 40960 |
| 100 | 750000 | 40960 |
| 200 | 1500000 | 40960 |

The variation in management cost according to MA size is given in table 2 and fig 4 shows the graph which shows management cost increases with increase in mobile agent size.

VI. INTRODUCTION TO WDM OPTICAL NETWORK

Optical communication is a form of data communication that uses light as the transmission medium. First-generation optical networks simply replaced copper wires with optical fibers. Due to much lower attenuation and interference, optical fiber has large advantages over copper wire in long-distance and high-demand applications.

New Open Distributed has offered network management a large set of solutions. For example worldwide TMN manager/agent environment [12] provides a generalized framework for the management of telecommunication networks. The centralized approach in this however entails drawback in scalability, reliability, efficiency and flexibility is consequently unsuitable for large heterogeneous networks.[13][14]

The advantages of optical fiber are given below.

Numbers of optical signals at different carrier wavelengths are simultaneously carried by the same fibers.

The speed at which optical signals are communicated is far greater than the speed at which data can be processed by electronic circuits.

International Journal of Innovative Research in Computer and Communication Engineering

(An ISO 3297: 2007 Certified Organization)

Vol. 2, Issue 1, January 2014

Therefore, optical fiber is being used by many telecommunications companies to transmit telephone signals, Internet communication, and cable television signals.

As of today, one single optical fiber can transport up to 320 Gbit/s and the capacity of more than 1Tbit/s is expected within next few years.

In the near future, the emergence of new photonic technologies in the field of transport networks, such as WDM (Wavelength-division Multiplexing) optical networks, will support a variety of services such as voice, audio, video and Internet traffic.

The incredible growth of the bandwidth through one fiber, as well as future IP/WDM mesh networks, require the implementation of some efficient mechanisms for the management of such networks, especially concerning reaction speed in case of fiber break or component damage.

Wavelength-division multiplexing (WDM) is a method to insert multiple channels or wavelengths over a single optical fiber as shown in Fig 5. WDM maximizes the use of the installed fiber base and allows new services to be quickly and easily provisioned over the existing fiber infrastructure. WDM offers bandwidth multiplication for carriers over the same fiber pair. WDM alleviates unnecessary fiber build-out in congested conduits and provides a scalable upgrade path for bandwidth needs.

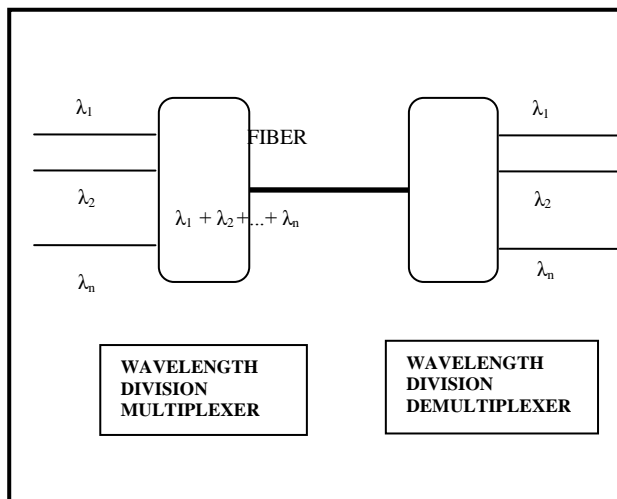

Fig 5 Simple WDM System

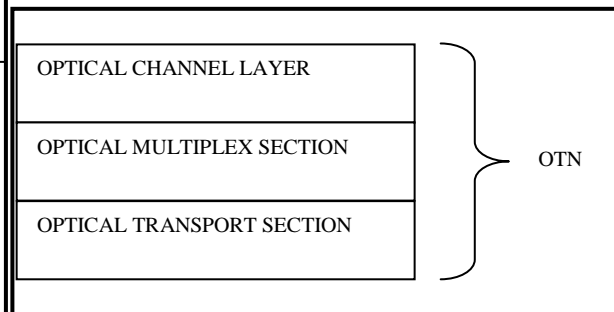

Fig 6 OTN Layer Architecture

Each message is assigned a different wavelength (frequency). Different wavelength lasers (called lambdas) transmit multiple signals. The various signals carried on the fiber can be transmitted at a different rate from each other.

The current trend in the networking world is the development of a paradigm that enables the transport of IP traffic over optical networks. Still, cost-effective transport solutions based on IP/WDM networks are attractive only if they can deal with legacy systems like SDH/WDM or ATM/SDH/WDM. We must therefore consider that IP/WDM and SDH/WDM need to co-exist on the same optical infrastructure in order to ensure efficient migration. Owing to the inherent C/S nature of TMN environment the information flow between managers and agents increases. Consequently the time for making decisions depending on human intervention becomes a critical issue.

The introduction of intelligent and mobile agents within optical networks should lead to the reduction of the information flow through the management information channels and should moreover spare the usage of numerous protocol stacks. Owing to this approach, optical networks will become more generic. They will be able to support the future services requirements and as well as guarantee a fast reaction to the dynamic changes of traffic conditions. Moreover the automatic reconfiguration should further reduce human intervention thereby reducing the risk of errors and reaction time.

International Journal of Innovative Research in Computer and Communication Engineering

(An ISO 3297: 2007 Certified Organization)

Vol. 2, Issue 1, January 2014

VII. SETTING UP OF OPTICAL CHANNELS IN AN OPTICAL TRANSPORT NETWORK

Optical Transport network (OTN) is another name for optical WDM network, which is currently being standardized by the G.872 recommendation of ITU-T [15]. It is based on WDM technology, which allows multiplexing of several wavelengths and leads to a tremendous increase in available bandwidth through one single optical fiber.

OTN is defined by three sub-layers, which are the Optical Channel layer (OCH layer), the Optical Multiplexing Section layer (OMS layer) and the Optical Transport Section layer (OTS layer) as shown in Fig 6.

OCH layer acts as a server layer on which any kind of rate-independent clients (e.g. IP, SDH, ATM) can initiate connections between two nodes. A client is associated to one wavelength (or channel). The OCH layer contains a wavelength routing function, while OMS layer is responsible for ensuring integrity of a group of wavelength (wavelength multiplex) and the OTS layer is the interface between OMS and physical layer.

A physical device through which channels (also called λ - connections) are established for information flow in an OTN network is called Add-Drop multiplexer. A variant of this, called Reconfigurable Optical Add-Drop multiplexer (ROADM), is deployed across the OTN networks for long distance data transmissions. It can add, drop, pass or redirect modulated light beams of various wavelengths in an optical fiber network as shown in Fig 7.

The direction from where the combined wavelengths can enter ROADM is called degree. A given ROADM can have maximum 4 degrees. Each degree, shown in the Fig 3, consists of an optical amplifier unit and MUX/DEMUX unit for wavelength management.

The amplifier carries the OTS and OCC ports whereas OCH ports are present on client cards. As shown in Fig 8, each OTS port has 40 OCC ports or channels in it. For putting client traffic from OCH ports to OTS port, optical cross connects can be made only on degree basis. For example, in case of degree 1, only the OCH ports and OCC port belonging to degree 1 could be cross connected. OCC ports are connected across the degrees by means of pass through cross connects.

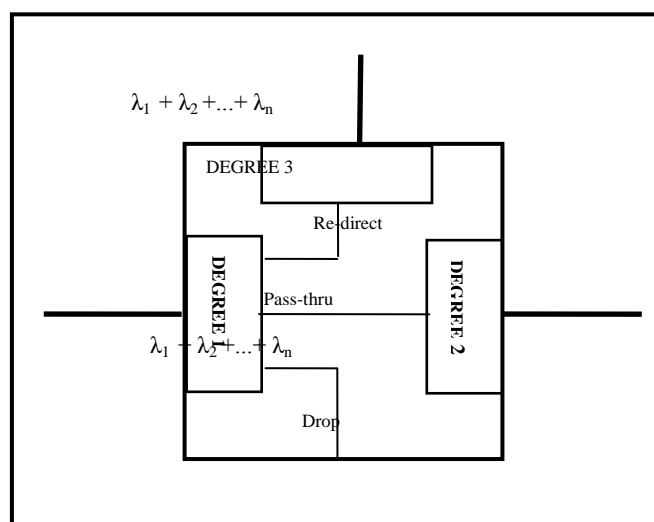

Fig 7 ROADM with wavelength management

VIII. LAMBDA- CONNECTIONS COST COMPUTATION FOR AN OPTICAL TRANSPORT NETWORK

Fig 9 shows a typical Mesh topology of ROADM nodes where three different (Red, Orange and Yellow) Optical Channels are shown. Two are in between the Source Port (SP) of Nodes A and Destination Port (DP) of Node G and one is between Node B and Node G.

Each of the blue circles is a degree on a given node. Node A is a single degree node, Node B is a 4 degree node, and Node C is a two degree and so on. These degrees are numbered 1 to 4 in any manner.

Each degree consists of an optical amplifier unit and MUX/DEMUX hardware units. Amplifier card has OTS ports (also called Network Ports) and MUX/DEMUX unit supports OCH ports (pink circle).

Each OTS port has 40 OCC ports or channels in it. As there are (max) 4 degrees, there are 4 OTS ports and a given channel number, say 27, (OCC number 27) is present across all degrees.

International Journal of Innovative Research in Computer and Communication Engineering

(An ISO 3297: 2007 Certified Organization)

Vol. 2, Issue 1, January 2014

For putting the client signal (traffic) from OCH ports to OTS port, optical cross connects can be made ONLY on degree basis, i.e., say for degree 1, ONLY the OCH ports and OTS port belonging to degree 1 could be cross connected. OTS ports are connected across the degrees by means of pass-through cross connects.

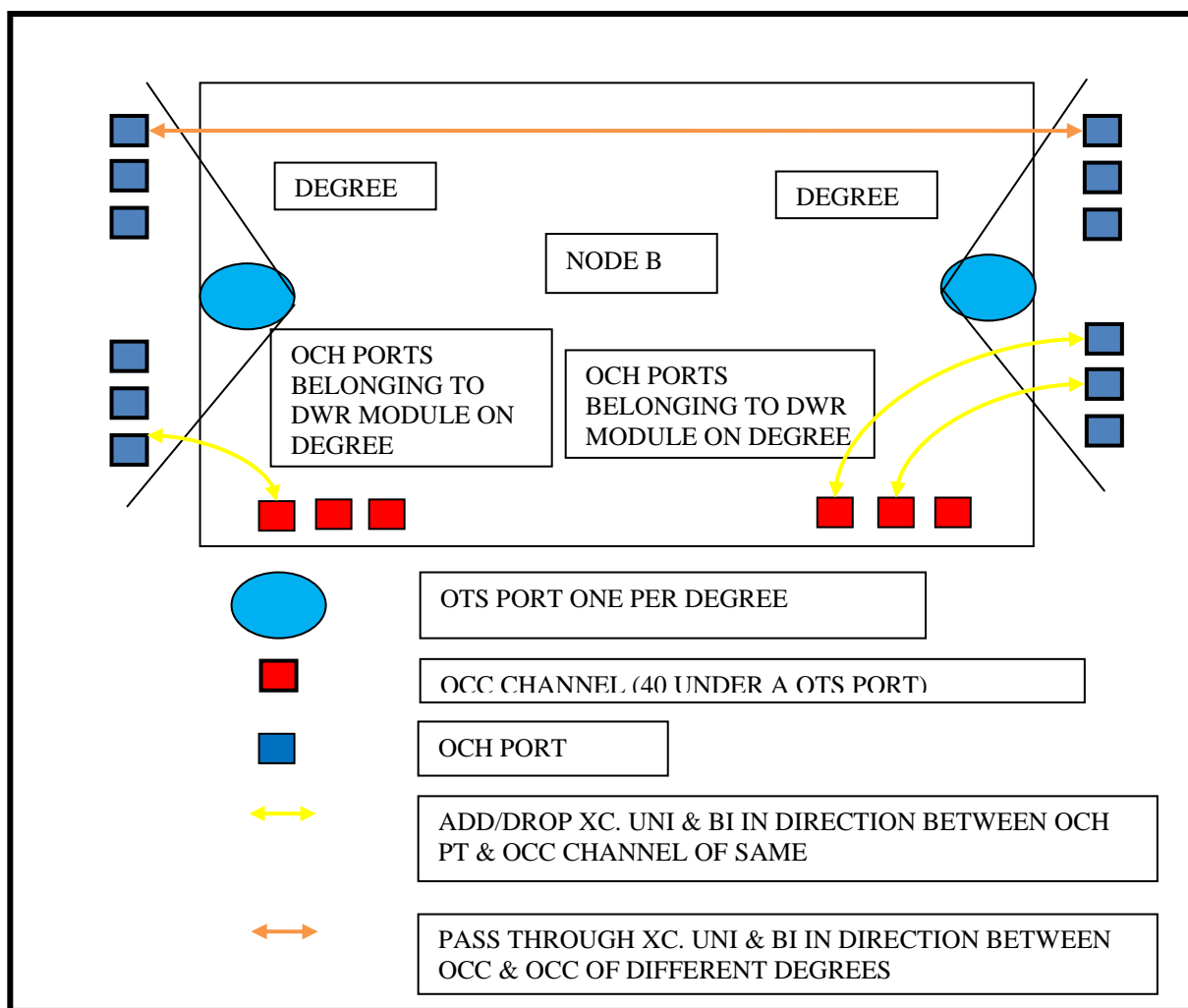

Fig 8 Node B Showing Degree, OTS, OCC & OCH Ports

In order to create an optical connection through the OTN network from a given source port (OCH) to the destination port, the availability of OCH, and OCC and OTS ports across the network is ascertained. In this work a mechanism is being proposed that creates optical channels across the OTN network elements.

IX. PROPOSED MECHANISM FOR OCH, OCC AND OTS PORT AVAILABILITY

Finally, complete content and organizational editing before formatting. Please take note of the following items when proofreading spelling and grammar: The user data or LAN connectivity is done on OCH port.

It can accept data up to 10Gbps. The user data can be put on to a given OCH port only if it is not a part of some other optical channel. The network system needs to ensure it. From a given OCH port, the data is taken to OCC channel for its entry into WDM domain. This can be done on degree basis.

A given OCH port and OCC port need to be part of the same degree.

International Journal of Innovative Research in Computer and Communication Engineering

(An ISO 3297: 2007 Certified Organization)

Vol. 2, Issue 1, January 2014

All the OCC ports finally multiplex into an OTS port and thereafter the multiplexed signals travel together on a single fiber.

The algorithm detail of the mechanism to check the availability of OCC & OCH port on source, destination and intermediate NE is given below.

A manager, an agent and management applications interact with each other, as discussed in previous chapters, to facilitate the channel creation in an automated manner across the OTN network.

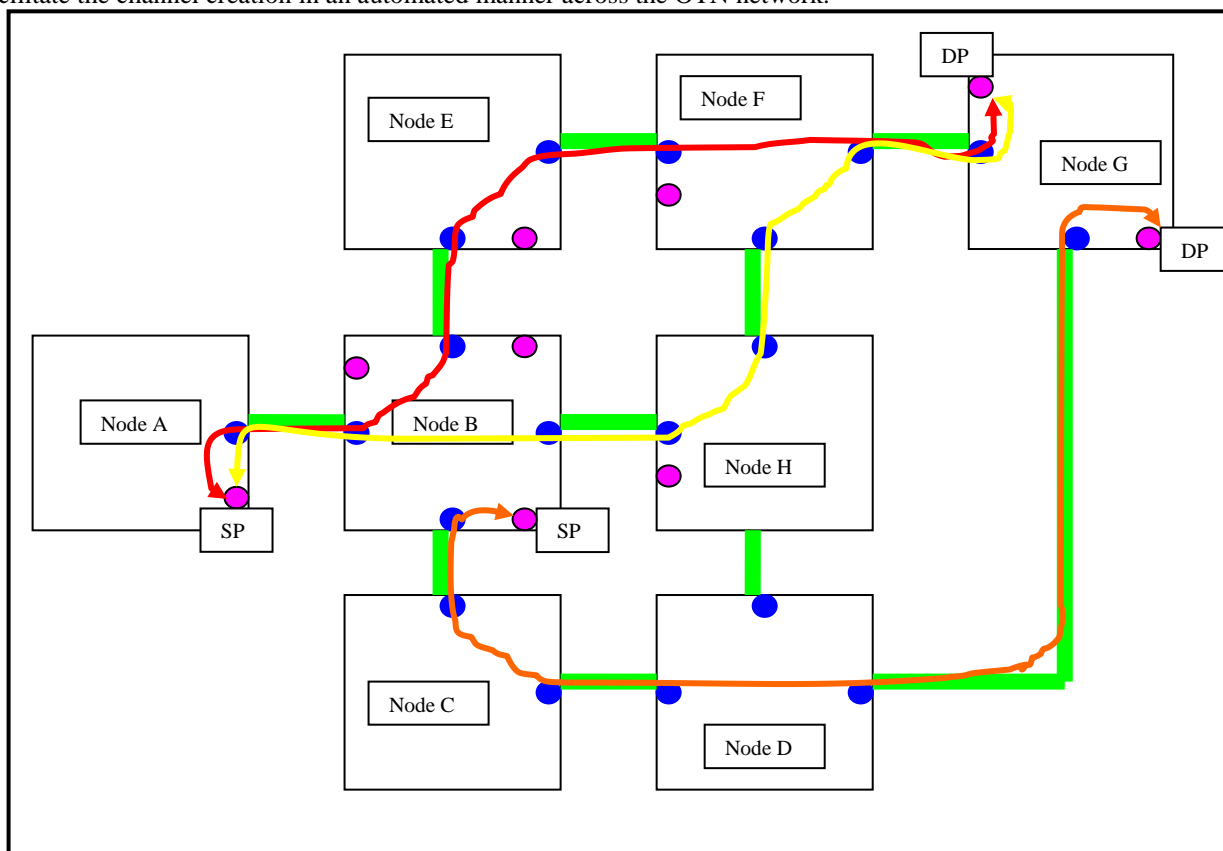

Fig 9 A Mesh Topology of ROADMs Nodes in an OTN Network

Following are certain validations which a Manager runs on its end to ensure the channel creation.

VALIDATION

1. Manager checks that destination port on source NE is in the same degree as source port and destination port is of type OCC belonging to an OTS port.
2. Manager checks that source port on destination NE is of type OCC belonging to an OTS port and on the same degree as destination port on destination NE
3. Manager checks source port and destination port for intermediate NE are of type OCC belonging to OTS port and belong to same channel

Let Q is the total number of ROADMs nodes present in an OTN network through which the channel creation has to run

Algorithm CreateChannel()

- ```

{
1. i=1;
2. Path[Array]=NULL
3. j=0
4. while(i<Q+1)
5. Start While

```



# International Journal of Innovative Research in Computer and Communication Engineering

(An ISO 3297: 2007 Certified Organization)

Vol. 2, Issue 1, January 2014

```
6. If (Destination OCC of Node[i] is free)
7. Start If
8. Make a cross - connection OCH-OCC (OCH to OCC)
9. Path[j]= Node[i]
10. j=j+1
11. End If
12. Else
13. Start Else
14. Return Destination OCC is not free
15. Exit
16. End Else
17. If (Node[i+1] is not the destination node)
18. Start If
19. If (Destination OCC on any degree is free)
20. Start If
21. Make a pass through connection OCC-OCC
22. i=i+1
23. Path[j]=Node{i+1}
24. j=j+1
25. Goto 17
26. End If
27. Else
28. Start Else
29. Return OCC is not free
30. i=i+1
31. Goto 17
32. End Else
33. End If
34. Else
35. Start Else
36. If (destination OCH is free)
37. Start If
38. Make a cross - connection OCC-OCH
39. Path[j]=Node[i+1]
40. End If
41. End Else
42. End While
43. Show path array of Nodes
}
```

Each of network management models has its own impact on response time and network bandwidth utilization. In client/server manager sends SNMP request to all nodes and get SNMP response from them. In-fact these requests themselves involve transfer of data in the form of network management traffic passing through system network incurring cost associated with it. This cost can be in term of bandwidth acquired for management data transfer or in term of time for which network is not free. For Mobile Agent it is the size of agent class and the amount of information which it will carry with it.

## X. COST COMPUTATION FOR CLIENT/SERVER MODEL

As shown in Fig 6, a central manager sends the required SNMP requests to various nodes in the OTN network to enquire about the availability of OCH, OCC and OTS ports.

# International Journal of Innovative Research in Computer and Communication Engineering

(An ISO 3297: 2007 Certified Organization)

Vol. 2, Issue 1, January 2014

Depending upon the required information, the algorithm explained above is run at the central manager and SNMP requests for setting up needed cross-connects between the OCH ports and OCC ports are issues from the central manager.

As discussed in earlier in the chapter, the management cost of client/server model in terms of no. of SNMP request/response and link coefficient would be computed as shown in equation (8).

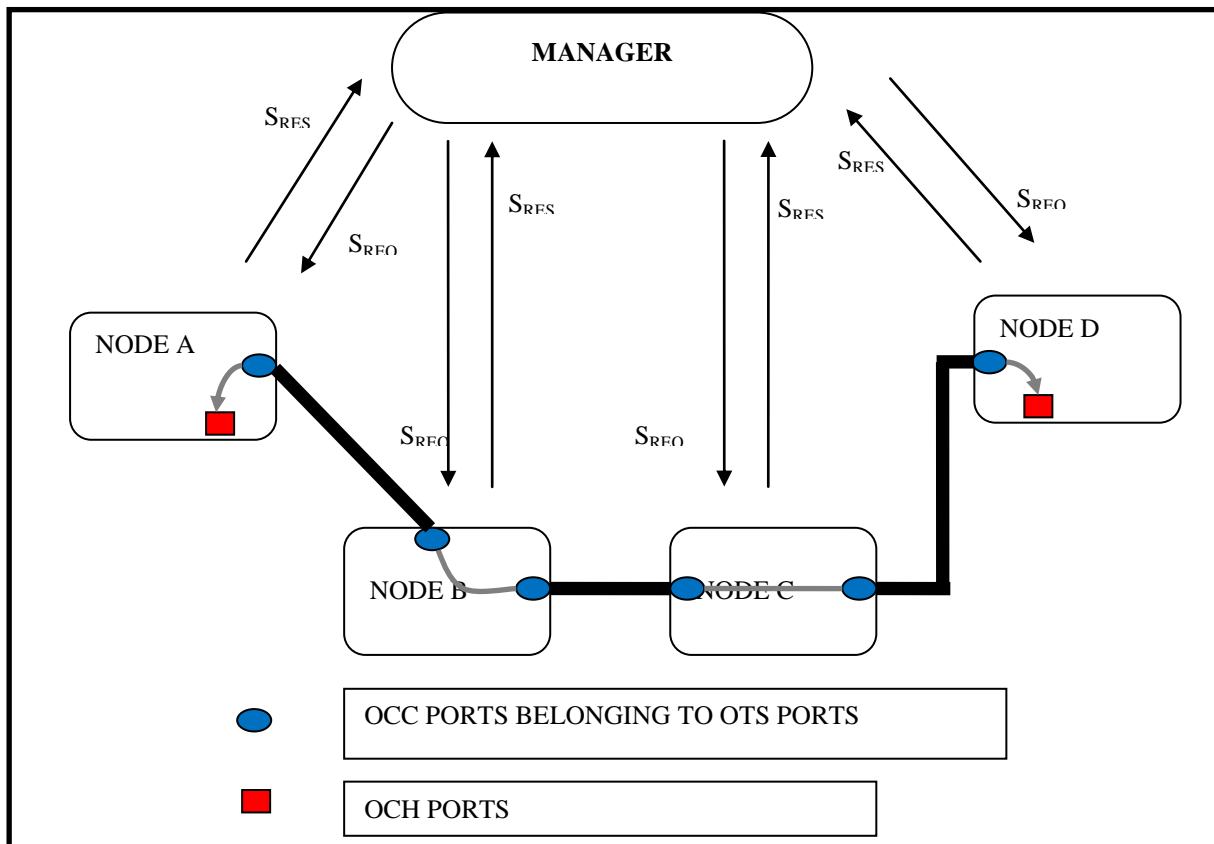

Fig 10. Client/Server NMS Model

$$C_{C/S} = K_{0,1} * (Sreq + Sres) * 3 + K_{0,2} * (Sreq + Sres) * 3 + K_{0,3} * (Sreq + Sres) * 3 + K_{0,4} * (Sreq + Sres) * 3 \quad (8)$$

A manager exchanges three requests/responses with an agent for setting up a cross-connect. Two requests are for checking the availability of OCH and OCC ports and one for setting up the cross-connect. A more generic form of the equation can be shown as expression (9)

$$C_{C/S} = \sum_{i=1}^n K_{0,i} * (Sreq + Sres) * 3 \quad (9)$$

Where

$K_{0,1}$  : the cost coefficient of manager to managed node link,

Sres : the size of SNMP response packet

Sreq : the size of SNMP request packet

Multiplication by 3 is three pair of requests and response are generated each for, to check availability of OCC & OCH port and to make connection between them respectively.

## XI. COST COMPUTATION FOR MOBILE AGENT MODEL

In case of mobile agent, as shown in Fig 11, SNMP request & response do not pass through network links. Mobile agent does all these request/response locally at each node. Mobile agents allow more and more of the network management intelligence to move closer to the devices unlike the centralized model.

# International Journal of Innovative Research in Computer and Communication Engineering

(An ISO 3297: 2007 Certified Organization)

Vol. 2, Issue 1, January 2014

In this model mobile agent runs locally on every node to find out the availability of OCH & OCC ports and also to make connection between them.

This saves the network management cost of request and response for each port and their connection, which is done in client server model.

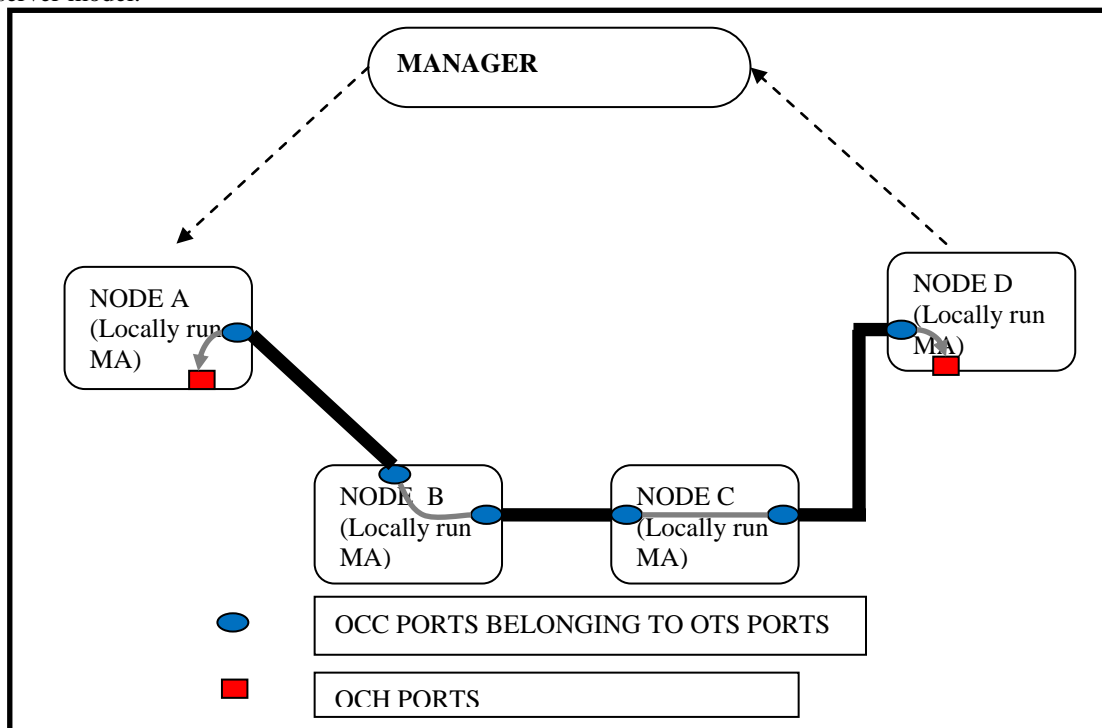

Fig 11.Mobile Agent NMS Model

As discussed earlier, the management cost of MA-based model in terms of no. of SNMP request/response, size of MA and link coefficient would be computed as shown in equation (10)

$$C_{MA} = K_{0,1} * SMA * 1 + K_{1,2} * SMA * 1 + K_{2,3} * SMA * 1 + K_{3,4} * SMA * 1 + K_{4,0} * SMA * 1 \quad (10)$$

As all operations are being performed locally by the MA and it doesn't carry any additional information with it, the overall cost would be computed as in equation (11)

$$C_{MA} = \sum_{i=1}^n K_{i,i+1} * SMA * 1 \quad (11)$$

Where

$K_{i,i+1}$  is cost coefficient of link

SMA is Size of Mobile Agent

Multiplication by 1 is that to enquire about free OCC & OCH port and to make connection between them is done locally.

## XII. COMPARISON BETWEEN CLIENT SERVER AND MOBILE AGENT MODEL

As discussed in earlier section, for theoretical quantitative evaluation of management cost for two network management models let us assume the following:

SNMP request packet size (Sreq) = 50 Bytes,

SNMP response packet size in small network= 75 bytes

Sma (MA size) is 1 KB =1024 Bytes,

Data accessed by the task manager (Sres) in CS paradigm =  $\beta$  times of Sma

(Size of mobile agent << raw data collected in Client/Server model)

The management cost in terms of flow of management traffic around the management station in CS paradigm is computed as follows.

$$C_{cs} = (Sreq + Sres) = 50 + \beta * Sma$$

# International Journal of Innovative Research in Computer and Communication Engineering

(An ISO 3297: 2007 Certified Organization)

Vol. 2, Issue 1, January 2014

Client Server cost computation

$$\begin{aligned}
 C_{C/S} &= \sum_{i=1}^n K_{0,i} * (S_{req} + S_{res}) * 3 \\
 &= K_{0,1} * (S_{req} + S_{res}) * 3 + K_{1,2} * (S_{req} + S_{res}) * 3 + K_{2,3} * (S_{req} + S_{res}) * 3 + K_{3,0} * (S_{req} + S_{res}) * 3 \\
 &= 10 * (50 + 75) * 3 * 4 \\
 &= 15000
 \end{aligned}$$

Client server cost computation with raw data of 15 times of SNMP response

$$\begin{aligned}
 C_{C/S} &= \sum_{i=1}^n K_{0,i} * (S_{req} + S_{res}) * 3 \\
 &= K_{0,1} * (S_{req} + S_{res} * 15) * 3 + K_{1,2} * (S_{req} + S_{res} * 15) * 3 + K_{2,3} * (S_{req} + S_{res} * 15) * 3 + K_{3,0} * (S_{req} + S_{res} * 15) * 3 \\
 &= 10 * (50 + 75 * 15) * 3 * 4 \\
 &= 141000
 \end{aligned}$$

For large networks SNMP response is  $\beta$  times of Sma, Take  $\beta = 2$

$$\begin{aligned}
 C_{C/S} &= \sum_{i=1}^n K_{0,i} * (S_{req} + S_{res}) * 3 \\
 &= K_{0,1} * (50 + 2 * 1024) * 3 + K_{1,2} * (50 + 2 * 1024) * 3 + K_{2,3} * (50 + 2 * 1024) * 3 + K_{3,0} * (50 + 2 * 1024) * 3 \\
 &= 10 * (50 + 1024 * 2) * 3 * 4 \\
 &= 251760
 \end{aligned}$$

Mobile agent cost computation

$$\begin{aligned}
 C_{MA} &= \sum_{i=1}^n K_{i,i+1} * SMA * 1 \\
 &= K_{0,1} * SMA * 1 + K_{1,2} * SMA * 1 + K_{2,3} * SMA * 1 + K_{3,4} * SMA * 1 + K_{4,0} * SMA * 1 \\
 &= 10 * 1024 * 1 * 4 \\
 &= 40960
 \end{aligned}$$

Based on the computation shown, the cost of traffic around management station is tabulated in Table 3 and shown in Fig 12.

Table 3 Traffic around Management Station in C/S vs MA

| No. Of polling times done | MA    | CS                                        |
|---------------------------|-------|-------------------------------------------|
| 1                         | 40960 | 15000                                     |
| 10                        | 40960 | 96000<br>(10 times of S <sub>res</sub> )  |
| 50                        | 40960 | 141000<br>(15 times of S <sub>res</sub> ) |
| 100                       | 40960 | 251760 ( $\beta=2$ )                      |

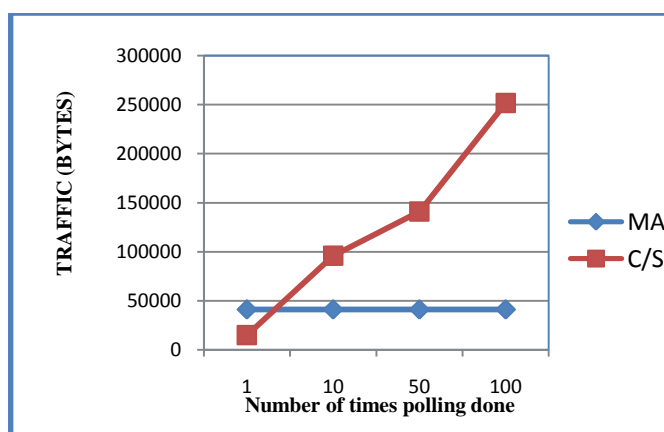

Fig 12 Traffic around management station

It may be noted from Table 3 that with the increase in number of polling, the management cost of C/S increases many fold as compared to MA model as also illustrated in Fig 12.



# International Journal of Innovative Research in Computer and Communication Engineering

(An ISO 3297: 2007 Certified Organization)

Vol. 2, Issue 1, January 2014

## XIII. CONCLUSION

Now a day's optical transmission gives a solution for tremendous increase of application and transfer of data over one node to other in an efficient manner. But in large network client server approach has various disadvantages which led the mobile agents to overcome the problem of client server and the flexibility increases efficiently.

In this chapter we shows the experimental results for client server and MA which shows client/server are better for small network and mobile agent are good for large network. An algorithm is proposed to find out the availability of OCH, OCC, & OTS port in optical network scenario and compare the theoretical results for both client server and mobile agent approach.

## REFERENCES.

- [1] Subramanian, M., Network Management Principles and Practice, Addison Wesley, 2000.
- [2] W. Stallings. SNMP, SNMPv2 and CMIP: The practical guide to network management standards. Addison-wesley publication, 1994.
- [3] Tripathi, A., Ahmed, T., Pathak, S., "Paradigms for Mobile Agent Based Active Monitoring Of Network Systems", IEEE, 2002.
- [4] Shamila Makki, Subbarao Wunnava, Next Generation Networks and Code Mobility. ISAST Transactions on Communications and Networking, No.1 Vol. 2, 2008.
- [5] S. Vinoski, "CORBA: Integrating Diverse Applications Within Distribute Heterogeneous Environments", IEEE Communications Magazine, Vol. 35, No. 2, 1997.
- [6] Liotta, G. Knight, and G. Pavlou, "Modeling Network and System Monitoring Over the Internet with Mobile Agents", IEEE, 1998.
- [7] T. Magedanz, K. Rothermel, and S. Krause, "Intelligent Agents: An Emerging Technology for Next Generation Telecommunications", INFOCOM '96, pp.24-28, 1996.
- [8] D. Raz, B. Shavitt, "An Active Network Approach for Efficient Network Management", Proceedings of the 1st International Working Conference on Active Networks (IWAN'99), LNCS Vol. 1653, pp. 220-231, 1999.
- [9] J. E. White, "Telescript Technology: The Foundation for the Electronic Marketplace", General Magic White Paper, 1994.
- [10] Joy et. al., "The Java Language Specification", 2nd ed. Reading, MA: Addison Wesley, 2000.
- [11] Acharya, M. Ranganathan, and J. Saltz, "Dynamic linking for mobile programs, In Mobile Object Systems: Towards the Programmable Internet", pp. 245-262, Springer-Verlag, 1997.
- [12] ITU M.3100 "Principles for a Telecommunications management network" May 96
- [13] Dialong Zhang, Werner Zorn, "Developing network management applications in an application-oriented way using mobile agent", Computer Networks and ISDN systems 30 (1998) 1551-1557
- [14] Daneil Rossier- Rammuz and Rudolf Scheurer "An Introduction to Optical Agents: Intelligent and Mobile Agents for WDM Optical Network Management" Springer US 2002 Online ISSN 978-0-387-35491-0
- [15]. ITU G.872, "Architecture of Optical Transport Networks", Pre Published version, April 1999.

## BIOGRAPHY

**Anish Saini** is Assistant Professor in the Department of Computer Science & Engineering, Echelon Institute of Technology. He received Master of Technology (M.Tech) in Computer Engineering (Networking) in 2012 from YMCA University of Science and Technology, Faridabad. His research interests are Computer Networks (wireless Networks), Optical Network, Algorithms, web 2.0 etc.

**Dr. Atul Mishra** is working as an Associate Professor in the Department of Computer Engineering, YMCA University of Science and Technology, Haryana, India. He holds a Masters Degree in Computer Science and Technology, from University of Roorkee (now IIT, Roorkee) and PhD in Computer Science and Engg. from MD University, Rohtak. He has about 16 years of work experience in the Optical Telecommunication Industry specializing in Optical Network Planning and Network Management tools development. His research interests include SOA, Network Management & Mobile Agents